



faveremrácsok





Urban faveremrács

44040301-V

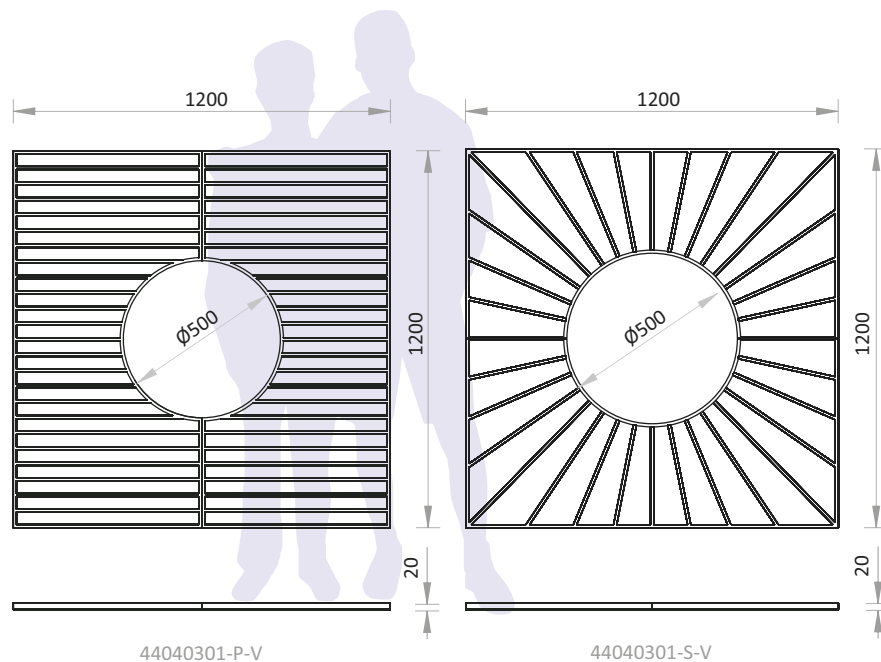

jellemzők

- tűzhorganyzás után porfestett acél szerkezet, párhuzamos vagy sugár irányú lamellákkal
- egyedi méretben is rendelhető
- súly: 50, illetve 42 kg

rögzítés

- mellékelt betonozó tuskés tűzhorganyzott szögvas kerettel



Forrás faveremrács

44040302-V



jellemzők

- tűzihorganyzás után porfestett acél szerkezet, párhuzamos vagy sugár irányú lamellákkal
- inox kötőelemek
- súly: 35, illetve 27 kg

rögzítés

- mellékelt betonozó tuskés tűzihorganyzott szögvas kerettel

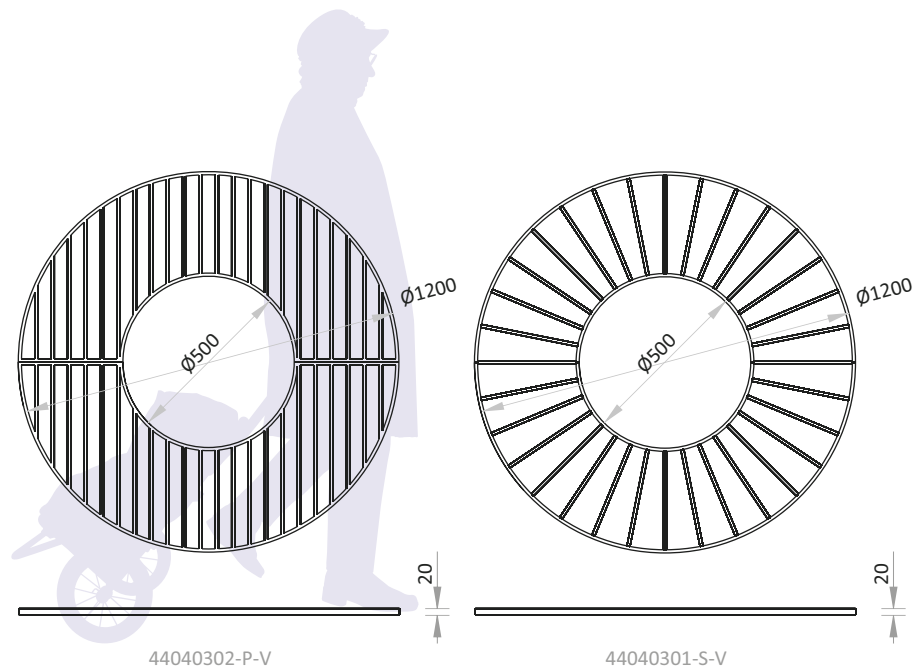

Oázis faveremrács

44040307-V, 44040308-V

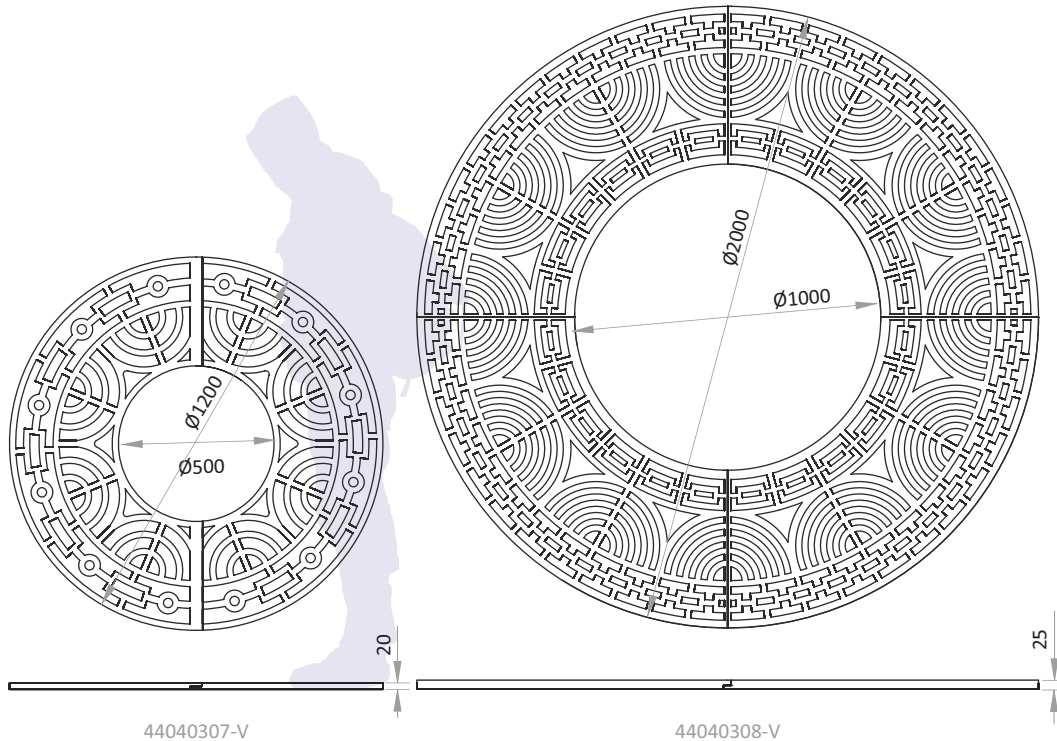

jellemzők

- alapozás után két rétegben színre festett öntöttvas rács
- súly: Oázis: 85 kg, Oázis XXL: 275 kg

rögzítés

- mellékelt betonozó tuskés tűzihorganyzott szögvas kerettel vagy alépitményel



Napsugár faveremrács

44040303-V



jellemzők

- alapozás után két rétegben színre festett öntöttvas rács
- súly: 45 kg

rögzítés

- mellékelt betonozható vagy betonozó tüskés tűzihorganyzott szögvas kerettel

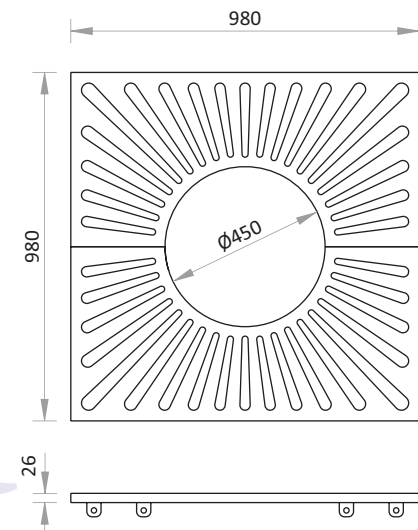
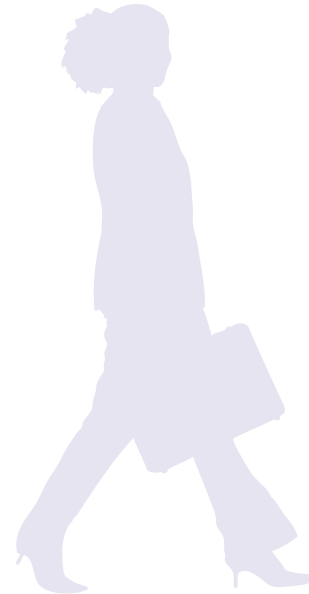

Lélegző faveremrács

44040304-V

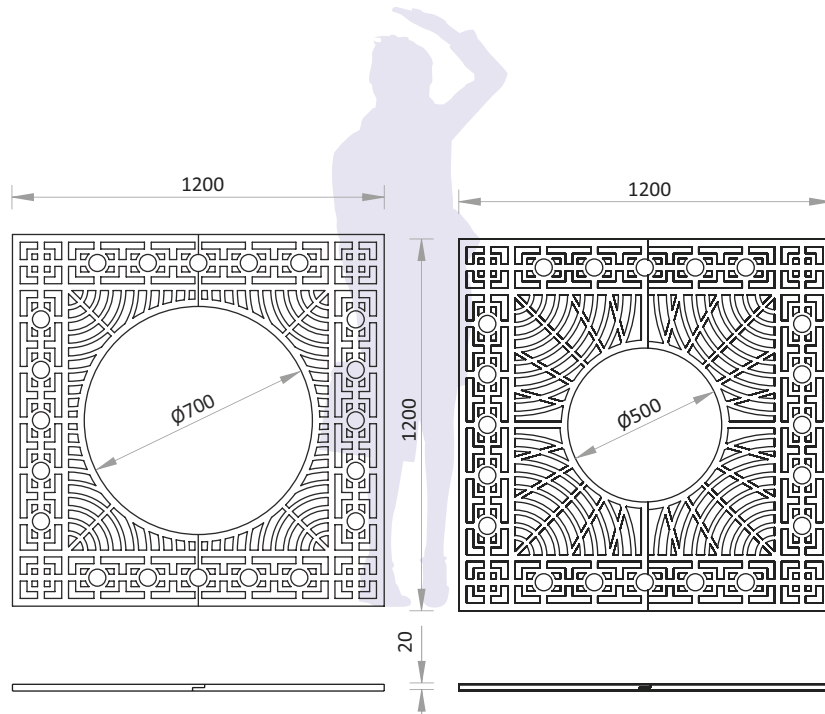

jellemzők

- alapozás után két rétegben színre festett öntöttvas rács
- 500 vagy 700 mm belső átmérővel rendelhető
- súly: 105 kg

rögzítés

- mellékelt betonozó tuskés
tüzhorganyzott szögvas kerettel



Konstruktív faveremrács

44040305-V



jellemzők

- alapozás után két rétegben színre festett öntöttvas rács
- súly: 230 kg

rögzítés

- mellékelt tüzhorganyzott aléptálcával

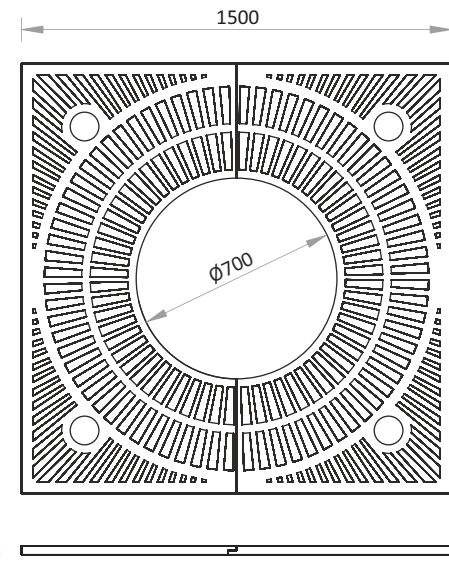
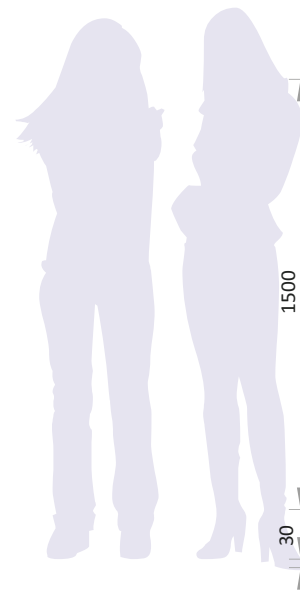

Konstruktív óriás faveremrács

44040306-V

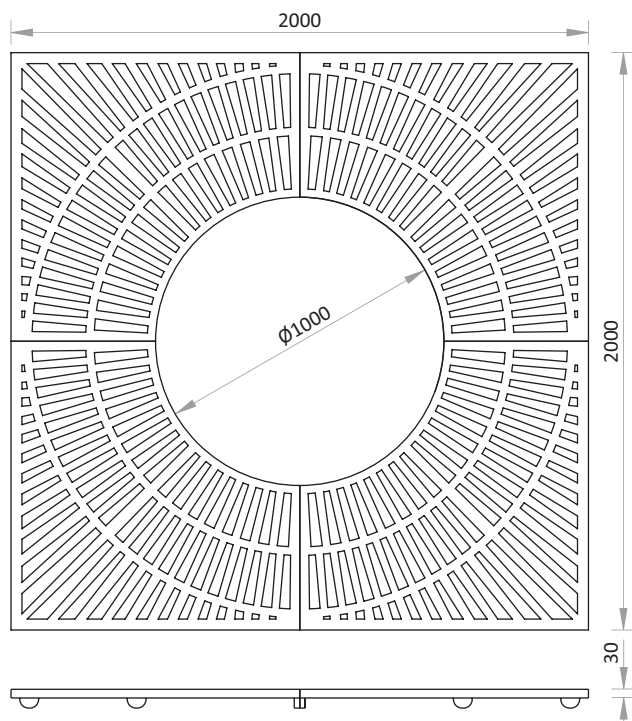

jellemzők

- alapozás után két rétegben színre festett öntöttvas rács
- súly: 342 kg

rögzítés

- mellékelt tűzihorganyzott aléptámmal



Győri favédőkeret

44040309-50-V, 44040309-70-V

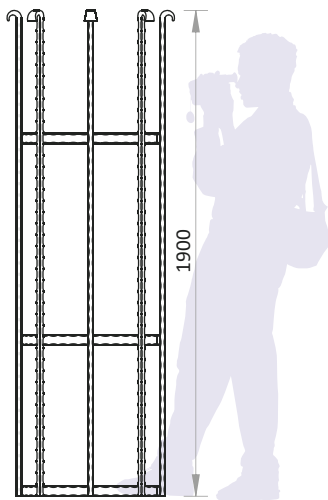
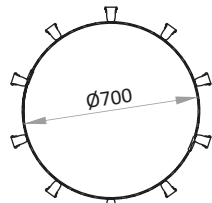
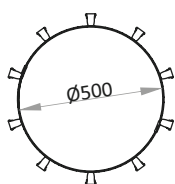

44040309-50-V

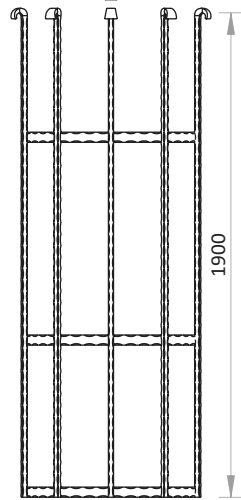

44040309-70-V

jellemzők

- mángorolt és tűzikovácsolt, két fél darabból álló acélszerkezet, tűzihorganyzás után porfestve, inox kötőelemekkel
- súly: 38, illetve 55 kg

rögzítés

- megfelelő méretű faveremrácsainkhoz csavarral rögzíthető



Forrás favédőkeret

44040311-50-V, 44040311-70-V



jellemzők

- tűzihorganyzás után porfestett acélszerkezet, inox kötőelemekkel
- súly: 35, illetve 50 kg

rögzítés

- megfelelő méretű faveremrácainkhoz csavarral rögzíthető

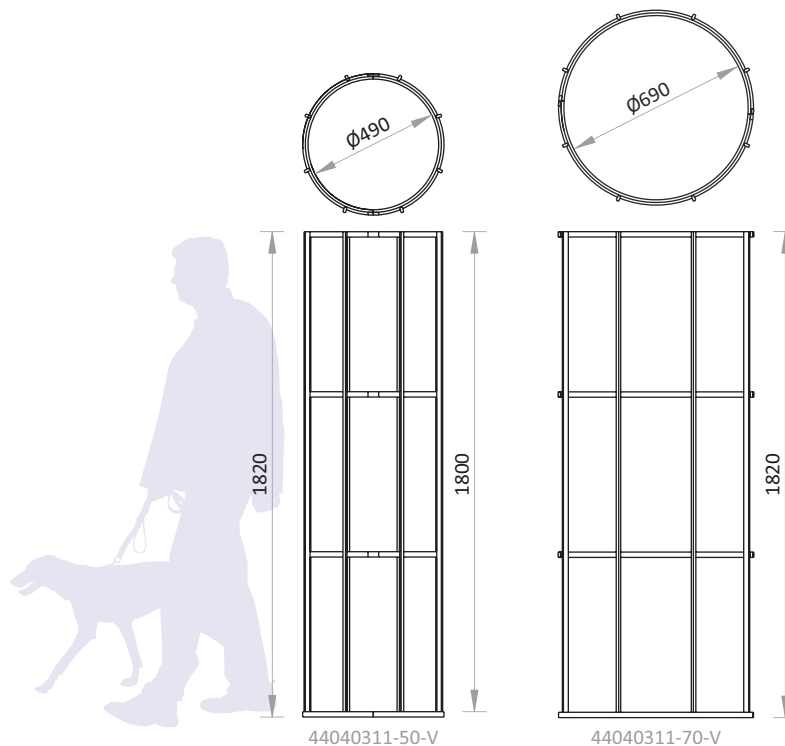

44040311-50-V

44040311-70-V

Juhar

favédőkeret

44040310-V

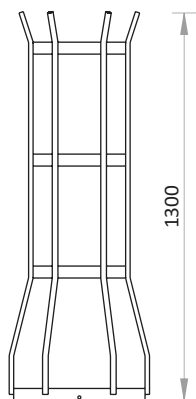
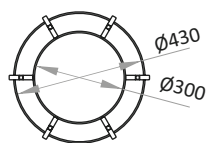

jellemzők

- mángorolt acélszerkezet, tűzihorganyzás után porfestve, inox kötőelemekkel
- súly: 15 kg

rögzítés

- a 450 mm belső átmérőjű Napsugár faveremrácshoz csavarral rögzíthető